

- Elegance look, profound technical, precise dimension.
- Range of Medium Duty Cabinets of Durable Modular construction.
- 1000kg maximum carrying capacity.
- The front door and back door are mesh door. The front door have camber and semicircle two types. Available with density vented front/rear locking double section door, enable ventilation and reliable operation.
- Wire path on the top and bottom can be closed.
- Install caster and support feet at the same time.
- High grade knob and lock.
- Wire groove with Wide cable manager on the two sides.
- The frame can be removed according to the requirement "U" as marked in the frame.
- Detachable composite structure, more convenient for being shipped.



PRODUCT INFORMATION

Part Number	Product Description
GN-002-6032	Giganet 32U Width 600mm Depth 1000mm Glass Door Cabinet
GN-002-6732	Giganet 32U Width 600mm Depth 1070mm Glass Door Cabinet
GN-002-6232	Giganet 32U Width 600mm Depth 1200mm Glass Door Cabinet

STANDARD: Comply with ANSI/EIA RS-310-D, IEC297-2, DIN41494;
PART1, DIN41494; PART7, GB/T3047; 2-92STANDARD

SCHEMATICS:

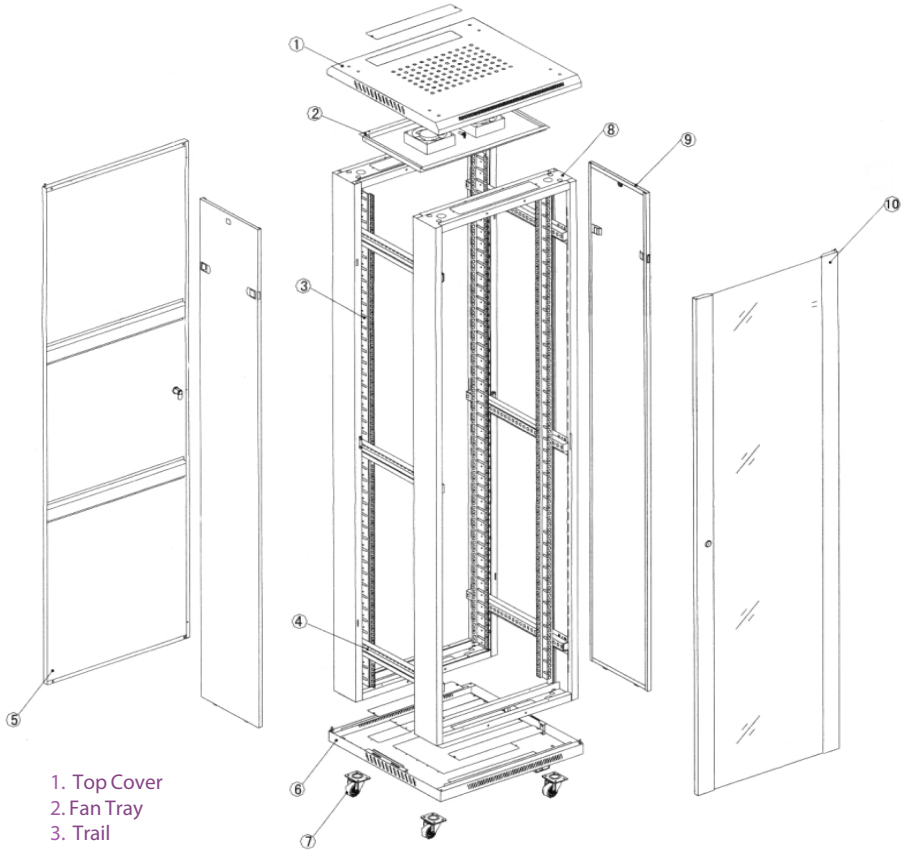

1. Top Cover
2. Fan Tray
3. Trail
4. Connector bar
5. Rear door
6. Bottom
7. Castor
8. Frame
9. Side door
10. Front door

Material: SPCC quality cold rolled steel

Thickness: Square hole strips 2.0mm, others 1.2mm

Color: RAL9004 (Signal Black),

RAL7044 (Silk Grey - on special order)

Surface finish: degrease, acid pickling, rust prevention and parkerizing, pure water cleaning, static electricity plastic painting