

Giganet 120mm End Cap is used for closing off open ends of the channel or fittings.

FEATURES

Network Reliability
Reduction in installation time and cost
Enable future expansion
Flame retardant material rated GB/T2048-2008 FV-0
RoHS and ABS compliant
Ideal solution for optical raceway requirement and application

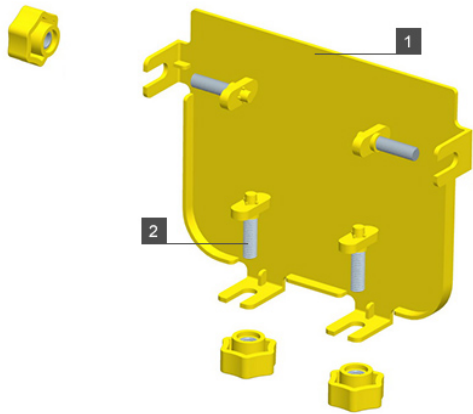

- 1.120 End Cap x1
- 2.T-shape Screw x4
- 3.Plastic Twist Nut x4

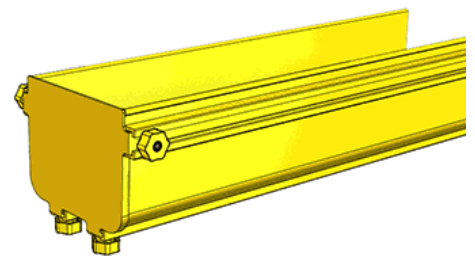
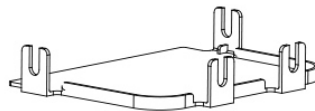
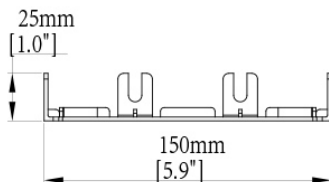
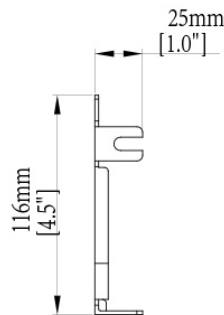
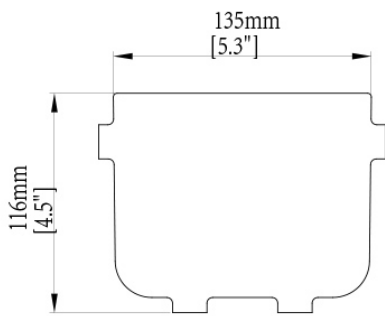
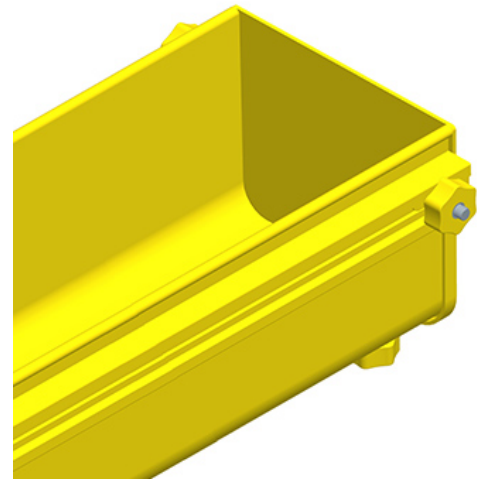

PRODUCT INFORMATION

Part Number	Product Description
GN-100-120-EC	Giganet 120mm End Cap Kit